

950 & 951 Series

Short Backset Mortice Locks



950 Series Short Backset Mortice Deadlocks

The 950 Series, swing bolt deadlocks are suitable for narrow stile hinged or pivoted doors. The positive action deadbolt is locked either by key, turn or BCA compliant lever. Also suitable for sliding doors where lock can be installed to door jamb and deadbolt engages strike mounted in face of door. Bolt available in 22mm or 37mm projection.

Materials

Zinc plated steel lock case with hardened steel side plates.
Brass cylinder, turn or lever.

Backset

23mm

Bolt

5 Leaves riveted together, with anti-saw core and 22mm or 37mm bolt projection.

Door Thickness

Suits narrow stile hollow sections with a minimum 28mm internal thickness and maximum 58mm external thickness. Suits timber doors 32mm to 58mm thick (extended cylinders available for thick doors).

Cylinder

Standard dormakaba 130 type oval cylinder with M616 cam.

Turn

FA310 as Standard or FA305 as spare part, SB311 - 45mm lever snib and SB312 - emergency escape lever handle, all with M615 turn cam.

Handing

The 950 Series is non handed.

Disabled Access



A selection of the 950 Series complies with AS1428 - Design for Access and Mobility, depending on turn snib selection.

Finishes

Standard finish is satin chrome plate (SCP) trims and clear anodised (CA) aluminium faceplate. Faceplates to suit timber doors are satin stainless steel (SSS).

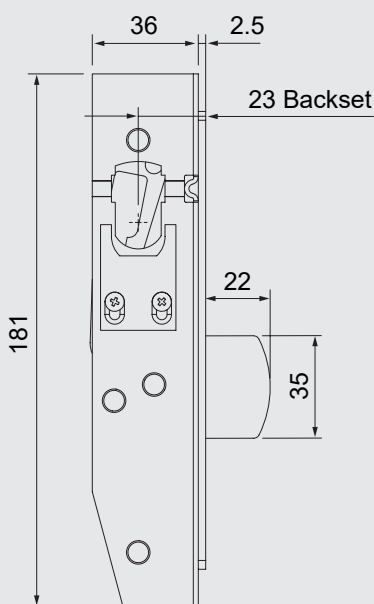

950-22 lock body

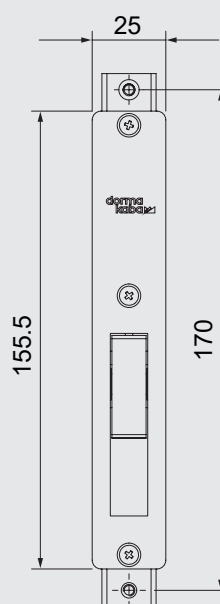

Face plate

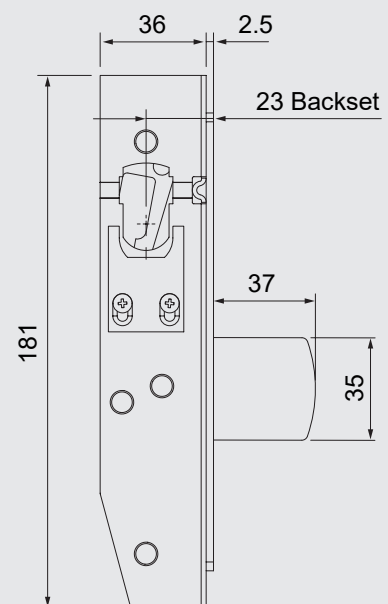

950-37 lock body

950 Series - Functions

22mm Bolt

Function code	Item	Article Number	Description	Finish
950 Series				
	950-22SCP-C4	9400000001197	950 LOCK BODY WITH 22MM BOLT INCL: 2 ESCUTHEONS, C4 CYLINDER AND CASE FIXED TURN	SCP
	950-22SCP-C4D	9400000001198	950 LOCK BODY WITH 22MM BOLT INCL: 2 ESCUTCHEONS AND C4 CYLINDERS	SCP
	950-22SCP-LC	9400000001199	950 LOCK BODY WITH 22MM BOLT INCL: 2 ESCUTCHEONS AND 2 CAMS	SCP
950 Series - Including Escape Lever SB312SCP				
	950L-22SCP-C4	9400000001203	950 LOCK BODY WITH 22MM BOLT INCL: CASE FIXED ESCAPE TURN	SCP
	950L-22SCP-LC	9400000001204	950 LOCK BODY WITH 22MM BOLT INCL: C4 CYLINDER AND CASE FIXED ESCAPE TURN	SCP

950 Series - Functions

37mm Bolt

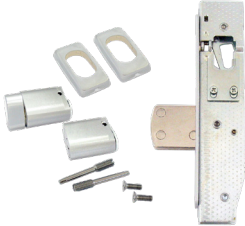
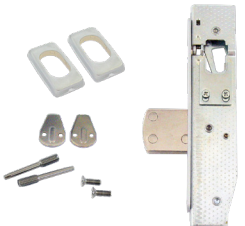
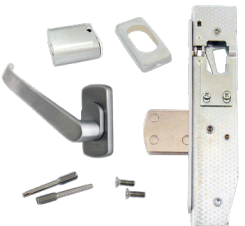
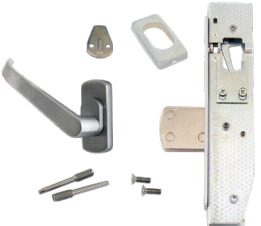
Function code	Item	Article Number	Description	Finish
950 Series				
	950-37SCP-C4	9400000001200	950 LOCK BODY WITH 37MM BOLT INCL: 2 ESCUTHEONS, C4 CYLINDER AND CASE FIXED TURN	SCP
	950-37SCP-C4D	9400000001201	950 LOCK BODY WITH 37MM BOLT INCL: 2 ESCUTCHEONS AND C4 CYLINDERS	SCP
	950-37SCP-LC	9400000001202	950 LOCK BODY WITH 37MM BOLT INCL: 2 ESCUTCHEONS AND 2 CAMS	SCP
950 Series - Including Escape Lever SB312SCP				
	950L-37SCP-C4	9400000001205	950 LOCK BODY WITH 37MM BOLT INCL: CASE FIXED ESCAPE TURN	SCP
	950L-37SCP-LC	9400000001206	950 LOCK BODY WITH 37MM BOLT INCL: C4 CYLINDER AND CASE FIXED ESCAPE TURN	SCP

951 Series Short Backset Mortice Deadlocks

The 951 Series, swing bolt deadlocks are suitable for narrow style sliding doors. The positive action deadbolt includes a hooked design to engage and lock into latching strike plate when bolt is in the thrown position. The deadbolt is locked or unlocked by either by key, turn or BCA compliant lever.

Materials

Zinc plated steel lock case with hardened steel side plates.
Brass cylinder, turn or lever.

Backset

23mm

Bolt

Leaves riveted together, with anti-saw core and 29mm projection.

Door Thickness

Suits narrow style hollow sections with a minimum 28mm internal thickness and maximum 58mm external thickness. Suits timber doors 32mm to 58mm thick (extended cylinders available for thick doors).

Cylinder

Standard dormakaba 130 type oval cylinder with M616 cam.

Turn

FA310 as Standard or FA305 as spare part, SB311 - 45mm lever snib and SB312 - emergency escape lever handle, all with M615 turn cam.

Handing

The 951 Series is non handed.

Disabled Access



A selection of the 951 Series complies with AS1428 - Design for Access and Mobility, depending on turn snib selection.

Finishes

Standard finish is satin chrome plate (SCP) trims and clear anodised (CA) aluminium faceplate.

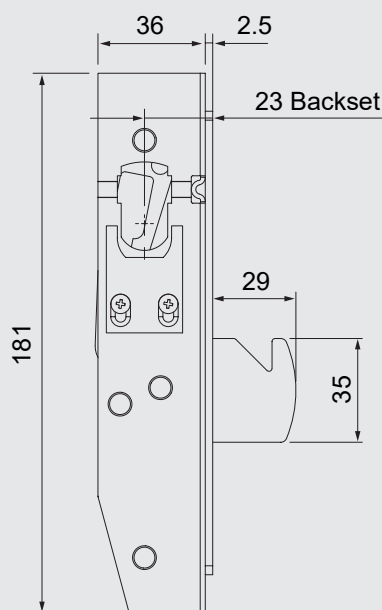



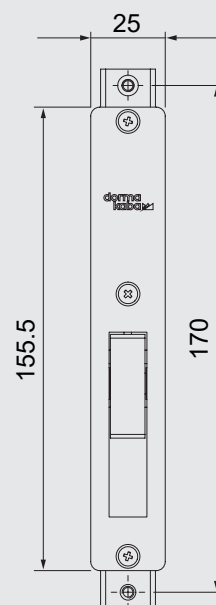

951 lock body





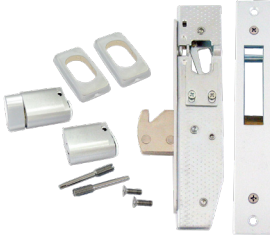
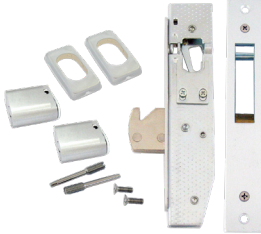



Face plate

951 Series - Functions

29mm Bolt

Function code	Item	Article Number	Description	Finish
951 Series				
	951SCP-C4	9400000001210	951 LOCK BODY WITH 29MM BOLT INCL: 2 ESCUTCHEONS, C4 CYLINDER AND CASE FIXED TURN	SCP
	951SCP-C4D	9400000001211	951 LOCK BODY WITH 29MM BOLT INCL: 2 ESCUTCHEONS AND C4 CYLINDERS	SCP
	951SCP-LC	9400000001212	951 LOCK BODY WITH 29MM BOLT INCL: 2 ESCUTCHEONS AND 2 CAMS	SCP
951 Series - Including Escape Lever SB312SCP				
	951LSCP-C4	9400000001208	951 LOCK BODY WITH 29MM BOLT INCL: CASE FIXED ESCAPE TURN	SCP
	951LSCP-LC	9400000001209	951 LOCK BODY WITH 29MM BOLT INCL: C4 CYLINDER AND CASE FIXED ESCAPE TURN	SCP

950 and 951 Series Accessories

Function code	Item	Article Number	Description	Finish
	M615	940000002595	CAM - M615 FUNCTION - TURN CAM CAM RABBIT EAR TO SUIT TURN OR LEVER	SCP
	M616	940000002596	CAM - M616 FUNCTION - CYLINDER CAM CAM TO SUIT 950 KEYED CYLINDER	SCP
	FA950	940000007025	ESCUTCHEON - RECTANGULAR	SCP
	FA959	940000002315	ESCUTCHEON - OVAL	SCP
	FA305	940000002304	TURN - STANDARD CASE FIX	SCP
	SB311	940000003102	SHORT BACKSET CASE FIXED SNIB LEVER	SCP
	SB312	940000003103	SHORT BACKSET ESCAPE LEVER	SCP

STRIKE BOX - Strike Plate Assembly for Timber Doors

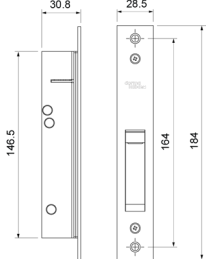
	951-030	940000001207	STRIKE BOX STRIKE PLATE ASSEMBLY FOR TIMBER DOORS	SCP
-------------------------------------------------------------------------------------	---------	--------------	------------------------------------------------------	-----

FACE PLATE - Timber Doors

	FP022	940000002327	TO SUIT 950 LOCK	SSS
	FP029	940000002328	TO SUIT 951 LOCK	SSS
	FP037	940000002329	TO SUIT 950 LOCK	SSS



**Door
Hardware**



**Entrance
Systems**



**Electronic
Access & Data**



**Interior Glass
Systems**



**Lodging
Systems**



**Mechanical
Key Systems**



Safe Locks



Services

Our Sustainability Commitment

We are committed to fostering a sustainable development along our entire value chain in line with our economic, environmental and social responsibilities toward current and future generations.

We seek an open, transparent dialogue with all stakeholders to define strategies and actions based on clear targets and continuous improvement, and we actively report on our progress.

DHW_950 & 951 Series Short Backset Mortice Lock Brochure Brochure_JULY 2023 DHW00017.
Subject to change without notice

dormakaba Australia

Head Office
12-13 Dansu Court
Hallam VIC 3803
T 1800 675 411
info.au@dormakaba.com
www.dormakaba.com.au

dormakaba New Zealand

Building P 61-69 Patiki Road
1026 Avondale/Auckland
New Zealand
T: 0800 436 762
info.nz@dormakaba.com
www.dormakaba.com.au